

Pneumatic active suspension system for a one-wheel car model using fuzzy reasoning and a disturbance observer

YOSHIMURA Toshio[†], TAKAGI Atsushi

(Department of Mechanical Engineering, Faculty of Engineering, The University of Tokushima,
Minamijosanjima-cho 2-1, Tokushima 770-8506, Japan)

[†]E-mail: yosimura@me.tokushima-u.ac.jp

Received July 5, 2004; revision accepted July 12, 2004

Abstract: This paper presents the construction of a pneumatic active suspension system for a one-wheel car model using fuzzy reasoning and a disturbance observer. The one-wheel car model can be approximately described as a nonlinear two degrees of freedom system subject to excitation from a road profile. The active control is composed of fuzzy and disturbance controls, and the active control force is constructed by actuating a pneumatic actuator. A phase lead-lag compensator is inserted to counter the performance degradation due to the delay of the pneumatic actuator. The experimental result indicates that the proposed active suspension improves much the vibration suppression of the car model.

Key words: One-wheel car model, Active suspension system, Fuzzy reasoning, Pneumatic actuator, Disturbance observer
doi:10.1631/jzus.2004.1060 **Document code:** A **CLC number:** TH16

INTRODUCTION

Investigation of active suspension systems for car models is recently increasing much because compared to passive and semi-active suspension systems, they offer better riding comfort to passengers of high-speed ground transportation. Generally, linear active suspension systems are derived by optimal control theory on the assumption that the car model is described by a linear or approximately linear system whose performance index is given in the quadratic form of the state variables and the active control of the car model (Hác, 1986; Hrovat, 1993; Yoshimura and Sugimoto, 1990). However, nonlinear and intelligent active suspension systems based on fuzzy reasoning (Lin *et al.*, 1993; Roukieh and Titli, 1993; Yeh and Tsao, 1994; Yoshimura *et al.*, 1997a; 1997b; 2003; Yoshimura and Watanabe, 2003), neural network (Moran and Nagai, 1994), and sliding mode control theory (Kurimoto and

Yoshimura, 1998; Yoshimura *et al.*, 2001), are proposed for complicated models with no negligibly strong non-linearity and uncertainty. Numerical and experimental results showed that such active suspension systems give relatively more satisfactory performance, but need more increasing loads to achieve active control, compared with the linear active suspension systems.

This paper proposes using fuzzy reasoning and a disturbance observer to establish an active suspension system of a one-wheel car model approximately described as a nonlinear two degrees of freedom system subject to excitation from a road profile. The active control is composed of the fuzzy and disturbance controls. The former is inferred by function-type fuzzy reasoning, and the latter is obtained from the disturbance observer that estimates the excitation from the road profile. The active control force is produced by a pneumatic actuator, and the car model's performance degra-

dition in the vibration suppression due to the delay of the pneumatic actuator is improved much by inserting a device after the sensors to measure the time responses of the acceleration, velocity and displacement of the car body.

ONE-WHEEL CAR MODEL

The experimental apparatus of a one-wheel car model vertically confined by two polls, due to the active control force generated by the pneumatic actuator is shown in Fig.1. The masses of the car body and wheel parts are respectively denoted as m_1 and m_2 , with displacements respectively expressed as z_1 and z_2 . The restoring force of the suspension part is practically assumed to be nonlinear, and consists of two coil springs with stiffness k_1 or four coil springs with stiffness k_1+k_1' , depending on the suspension deflection. Thus, for suspension deflection denoted as z_1-z_2 , the nonlinear restoring force $f(z_1-z_2)$ is assumed to be

$$f(z_1 - z_2) = \begin{cases} (k_1 + k_1')(z_1 - z_2) - ak_1' & \text{for } z_1 - z_2 > a \\ k_1(z_1 - z_2) & \text{for } |z_1 - z_2| \leq a \\ (k_1 + k_1')(z_1 - z_2) + ak_1' & \text{for } z_1 - z_2 < -a \end{cases} \quad (1)$$

where a is a positive constant. The non-linearity of the restoring force means that the restoring force becomes stronger as the suspension deflection becomes larger. The gravity mainly due to the masses, m_1 and m_2 , is supported by the mass m_3 whose displacement is expressed as z_3 , and the coil spring with stiffness K . The tyre part of the wheel mainly consists of air spring with stiffness k_2' . The excitation from the road profile is assumed to be the signal generated by the electric vibrator connecting the signal function generator. The damping force of the suspension part is assumed to be due to the Coulomb damping caused by contact with two polls and the viscous damping caused by the pneumatic cylinder, and is assumed to be linearly related with the damping coefficient c being considered as relatively small.

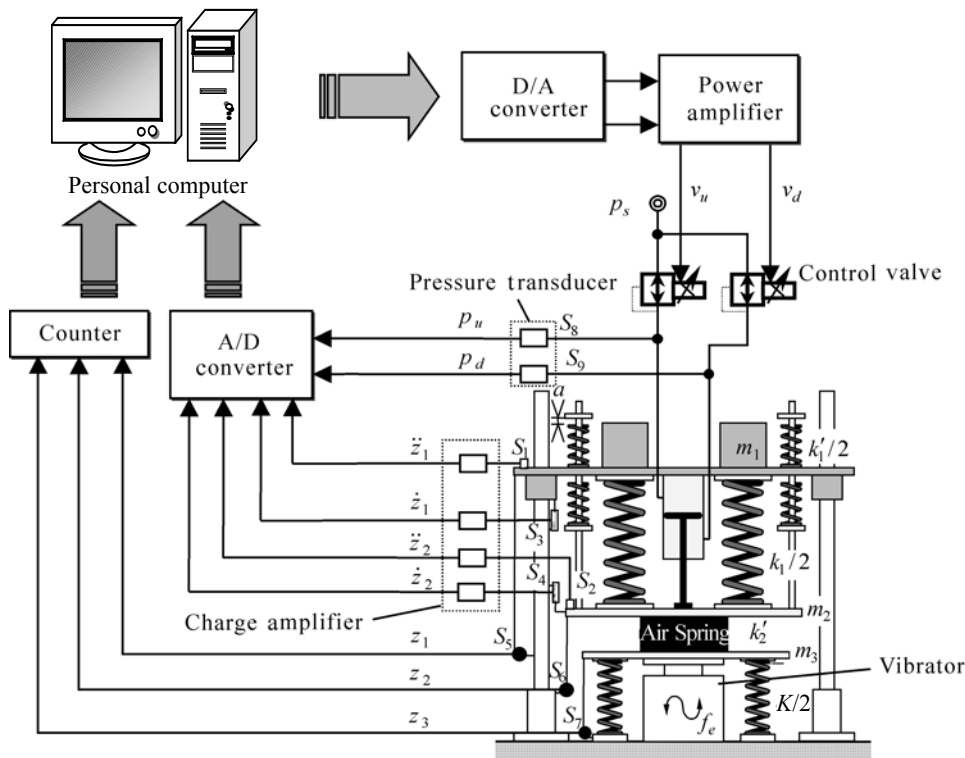

Fig.1 Experimental apparatus of one-wheel car model

Therefore, the equations of motion for the car model are given by

$$m_1\ddot{z}_1 + c(\dot{z}_1 - \dot{z}_2) + f(z_1 - z_2) = u \quad (2)$$

$$m_2\ddot{z}_2 - c(\dot{z}_1 - \dot{z}_2) - f(z_1 - z_2) + k_2'(z_2 - z_3) = -u \quad (3)$$

$$m_3\ddot{z}_3 - k_2'(z_2 - z_3) + Kz_3 = f_e \quad (4)$$

where u is the active control achieved by actuating the pneumatic actuator, and f_e is the exciting force generated by the electric vibrator. After dividing both sides of Eq.(4) by K , neglecting the resultant first term on the left-hand side of Eq.(4) as the effect of the term is considered relatively small compared with the effect of other terms, defining that

$$k_2 = \frac{k_2'K}{k_2' + K}, \quad w = \frac{f_e}{K}, \quad z_2 - w = \left(\frac{k_2'}{k_2}\right)(z_2 - z_3),$$

and substituting the above definitions into Eq.(3), the resultant equation becomes

$$m_2\ddot{z}_2 - c(\dot{z}_1 - \dot{z}_2) - f(z_1 - z_2) + k_2(z_2 - w) = -u \quad (5)$$

where w and $z_2 - w$ in Eq.(5) correspond respectively to the excitation from the road profile and the tyre deflection. Therefore, the one-wheel car model described by Eqs.(2) and (5) indicates a nonlinear two degrees of freedom system subject to excitation from the road profile.

The control part in the one-wheel car model consists of accelerometers (S_1 and S_2), velocity sensors (S_3 and S_4), and linear encoders (S_5 , S_6 and S_7). The state variables characterizing the car model can be directly measured; the control signal is calculated by using the personal computer based measured data of the state variables through the A/D converters and the counters, and the control valve of the pneumatic actuator is regulated by the control signal through the D/A converter and the power amplifier. Finally, active control u is achieved by actuating the pneumatic actuator when $u=77.0v$, with v being the voltage of the control valve.

CONSTRUCTION OF ACTIVE SUSPENSION SYSTEM

The active suspension system proposed here is constructed as follows. First, a compensator is constructed to deal with the performance degradation in the vibration suppression of the car model due to the delay of the pneumatic actuator and is inserted after the sensors to measure the time responses of the acceleration, velocity and displacement of the car body. Then the fuzzy control is achieved by using function-type fuzzy reasoning to reduce the computational load of inference, and the disturbance control is achieved by using the disturbance observer that estimates the excitation from the road profile. Finally, the active control is composed of a combination of fuzzy and disturbance controls, and the active control force is released by actuating the pneumatic actuator.

Compensator

The performance degradation in the vibration suppression of the car model due to the delay of the pneumatic actuator is countered by inserting the compensator. The transfer function for the pneumatic actuator is experimentally identified by the time response of the electro-pneumatic control valve subject to 1 V step input. The experimental and calculated time responses are shown in Fig.2, and the (calculated) transfer function is identified as

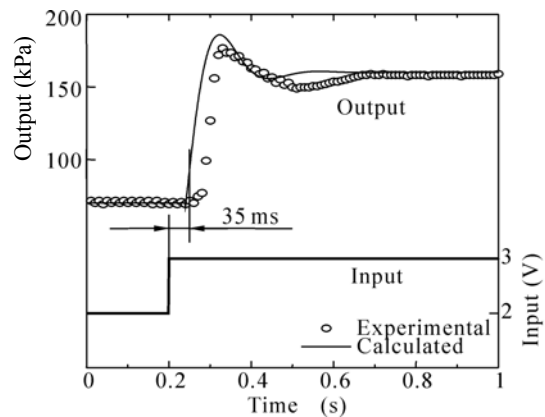

Fig.2 Time response of the actuator

$$G_a(s) = \frac{P_u(s)}{K_a V_u(s)} = \frac{900}{s^2 + 30s + 900} e^{-0.035s} \quad (6)$$

where $K_a=90$ kPa/V. The figure shows that the experimental and calculated time responses have good agreement. Compensating the performance degradation in the vibration suppression of the pneumatic actuator, the phase lead-lag element as the compensator is inserted after the sensors to measure the time responses of the acceleration, velocity and displacement of the car body. The transfer function for the compensator is assumed as

$$G_c(s) = (1 + saT_1)(1 + sbT_2) / [(1 + sT_1)(1 + sT_2)] \quad (7)$$

$a > 1, 0 < b < 1, T_1 > 0, T_2 > 0$

The parameters characterizing Eq.(7) are determined from the Bode diagram for the frequency response function $G_a(j\omega)G_c(j\omega)$ as

$$a = 4.5, T_1 = 0.01, b = 0.5, T_2 = 0.04$$

It is clearly seen from the Bode diagram shown in Fig.3 that the frequency response function with compensator compared to that without compensator, is characterized by increased gain and phase angle lead.

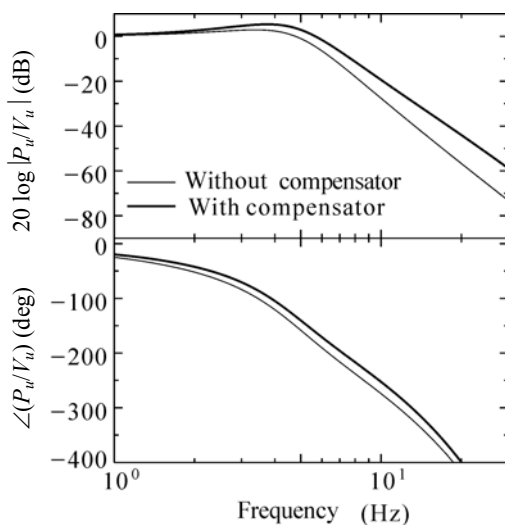

Fig.3 Frequency response function of the pneumatic actuator

Fuzzy reasoning

It is seen that the number of fuzzy control rules for inferring the defuzzified values in the conclusion parts increases more exponentially if the number of variables in the precondition parts increases more. To decrease the number of fuzzy control rules, the following function-type fuzzy reasoning

$$R_i: \text{if } s \text{ is } A_i \text{ then } u \text{ is } f_i(s) \quad i=1,2,\dots,n \quad (8)$$

is proposed where s is the variable and A_i is the fuzzy set with membership function $A_i(s)$ in the precondition parts, u is the fuzzy control and $f_i(s)$ is the function of s in the conclusion parts. As s is measured in s^0 , the degree of fitness ω_i is inferred as

$$\omega_i = A_i(s^0) \quad (9)$$

and the fuzzy control u_f is inferred as

$$u_f = \frac{\sum_{i=1}^n f_i(s^0)\omega_i}{\sum_{i=1}^n \omega_i} \quad (10)$$

Disturbance observer and active control

The aim of the disturbance observer is to estimate the excitation from the road profile and the disturbance control is constructed by using the estimate. Assuming that the state variables for the car model $(\dot{z}_1, z_1, \dot{z}_2, z_2)$ can be directly measured but that the excitation from the road profile w cannot be measured, then w is estimated by using the minimum-order observer (Fortman and Hitz, 1977) as the proposed disturbance observer.

Approximating the nonlinear restoring force $f(z_1-z_2)$ from the linear restoring force $k_1(z_1-z_2)$, and defining the augmented state vector x and the measurement vector y as

$$x = [\dot{z}_1 \quad z_1 \quad \dot{z}_2 \quad z_2 | w]^T \triangleq [y | w]^T$$

then the state equation is obtained as

$$\dot{x} = Ax + bu \quad (11)$$

where

$$\mathbf{A} = \left[\begin{array}{cccc|c}
 \frac{c}{m_1} & \frac{k_1}{m_1} & \frac{c}{m_1} & \frac{k_1}{m_1} & 0 \\
 1 & 0 & 0 & 0 & 0 \\
 \frac{c}{m_2} & \frac{k_1}{m_2} & \frac{c}{m_2} & \frac{k_1+k_2}{m_2} & \frac{k_2}{m_2} \\
 0 & 0 & 1 & 0 & 0 \\
 0 & 0 & 0 & 0 & 0
 \end{array} \right]$$

$$\Delta \equiv \left[\begin{array}{c|c}
 \mathbf{A}_{11} & \mathbf{A}_{12} \\
 \mathbf{0} & \mathbf{0}
 \end{array} \right]$$

$$\mathbf{b} = \left[\begin{array}{ccc|c}
 \frac{1}{m_1} & 0 & -\frac{1}{m_2} & 0 \\
 \hline
 \mathbf{0} & \mathbf{0} & \mathbf{0} & \mathbf{0}
 \end{array} \right]^T \triangleq [\mathbf{b}_1 \mid \mathbf{0}]^T$$

The estimate \hat{w} for w is done by using the minimum-order observer (Fortman and Hitz, 1977) as follows. Transform w into w^* so that

$$w^* = -\mathbf{T}\mathbf{y} + w \tag{12}$$

where

$$\mathbf{T} = [T_1 \ T_2 \ T_3 \ T_4]$$

Then, the estimate \hat{w}^* for w^* is derived from the following equation

$$\hat{w}^* = \hat{A}\hat{w}^* + \hat{\mathbf{J}}\mathbf{y} + \hat{\mathbf{b}}u \tag{13}$$

and the estimate \hat{w} for w is obtained from

$$\hat{w} = \mathbf{T}\mathbf{y} + \hat{w}^* \tag{14}$$

where

$$\hat{A} = -\mathbf{T}\mathbf{A}_{12}, \quad \hat{\mathbf{J}} = -\mathbf{T}(\mathbf{A}_{11} + \mathbf{A}_{12}\mathbf{T}), \quad \hat{\mathbf{b}} = -\mathbf{T}\mathbf{b}$$

It is clear from Eq.(13) that \hat{w}^* becomes stable when \hat{A} is negative; therefore T_3 is taken as positive, while the values of T_1, T_2 and T_4 can be arbitrarily selected.

The disturbance control is constructed to improve further the performance in the vibration suppression of the car model. It is constructed as $g_d \hat{w}$ where g_d is a constant. Therefore, the active control u is constructed as

$$u = u_f + g_d \hat{w} \tag{15}$$

EXPERIMENTAL RESULT

The parameters characterizing the experimental apparatus of the one-wheel car model are given by

$$\begin{aligned}
 m_1 &= 46.16 \text{ kg}, \quad m_2 = 13.4 \text{ kg}, \quad m_3 = 1.28 \text{ kg}, \\
 k_1 &= 6.8 \text{ kN/m}, \quad k_1' = 20 \text{ kN/m}, \quad k_2' = 100 \text{ kN/m}, \\
 K &= 100 \text{ kN/m}, \quad c = 400 \text{ Ns/m}, \quad a = 1.4 \text{ mm}
 \end{aligned}$$

and the nonlinear restoring force of the suspension part is denoted as in Fig.4. The excitation force generated by the electric vibrator is assumed to be random and have 5 Hz bandwidth. The sampling interval of the measurement and the active control is assumed to be 10 ms, and RMS values of the time responses of the state variables and the active control are computed by using the 10 s measurement data.

The variable s in the precondition part is assumed to be

$$s = [(\alpha \ddot{z}_1 + \beta \dot{z}_1 + \gamma z_1) / s_{\max}] \tag{16}$$

The variable s denotes the weighted sum of the acceleration, velocity and displacement of the car body where α, β and γ are respectively the weighting factors, and s_{\max} is the scaling factor. It is assumed that the fuzzy sets in the precondition part are denoted as P, Z and N , and that their membership functions are given as shown in Fig.5, the functions of s in the conclusion part are given as $f_P(s), f_Z(s)$ and $f_N(s)$, and the fuzzy rules are shown

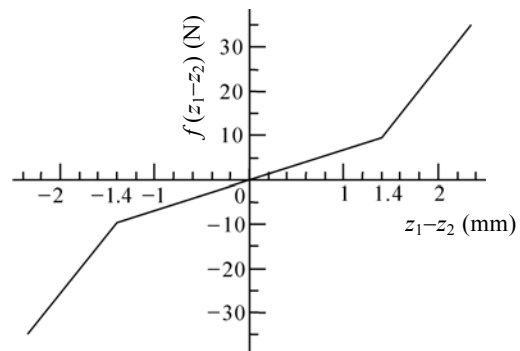

Fig.4 Nonlinear restoring force of the suspension part

in Table 1.

The parameters characterizing the fuzzy and disturbance controls are determined by minimizing the performance index given as

$$J = E[\lambda_1 \ddot{z}_1^2 + \lambda_2 (z_1 - z_2)^2 + \lambda_3 (z_2 - w)^2 + \rho u^2] \quad (17)$$

where

$$\lambda_1 = 1, \lambda_2 = 0.1, \lambda_3 = 0.1, \rho = 3 \times 10^{-4}$$

Repeating the procedure to minimize the performance index with respect to the parameters characterizing the fuzzy and disturbance controls, the parameters are finally given as

$$\alpha = 1, \beta = 35, \gamma = -200, s_{\max} = 3, g_w = 3500$$

The following four kinds of suspension systems are presented to compare the performance:

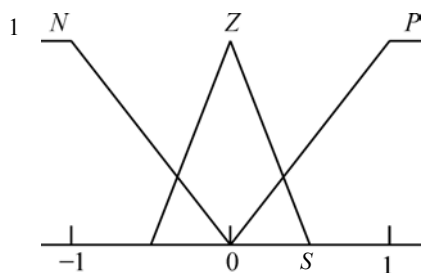

Fig.5 Membership functions of the fuzzy sets

Table 1 Fuzzy rules

Fuzzy set	Consequent part
<i>P</i>	$f_P(s) = -0.6 s $
<i>Z</i>	$f_Z(s) = 0$
<i>N</i>	$f_N(s) = 0.6 s $

- Method A: Passive suspension system;
- Method B: Active suspension system by fuzzy control without compensator;
- Method C: Active suspension system by fuzzy control with compensator;
- Method D: Proposed active suspension system by fuzzy control with VSS observer and compensator.

Table 2 shows RMS values of the time responses of the state variables and active control, and the performance index obtained by four kinds of methods; and denotes that Method D improves more the acceleration of the car body, the tyre deflection and the performance index than the other three methods, and improves more the active control than Methods B and C. Fig.6 shows the spectral density computed from the time response of the acceleration for the car body obtained by four kinds of methods, and denotes that Method D decreases more the peak of spectral density in the frequency region 2 Hz~6 Hz compared to the other three methods. Fig.7 shows that the estimation result of the excitation from the road profile obtained by the proposed disturbance observer is much improved as the exact and estimated time responses have good agreement.

The robustness of Method D is examined by varying the bandwidth of the excitation from the random profile from 5 Hz to 2.5 Hz where the parameters characterizing the active control in Method D are not varied. Table 3 shows the RMS values of the time responses of the identical variables shown in Table 2 and the performance index obtained by four kinds of methods, and indicates that Method D improves more the acceleration of the car body and the tyre deflection, and the perfor-

Table 2 RMS values of the time responses, and the performance index (5 Hz bandwidth)

	Method A	Method B	Method C	Method D	Unit
$\ddot{z}_1 (\times 10^{-1})$	8.732	6.343	6.126	6.078	m/s ²
$\dot{z}_1 (\times 10^{-2})$	3.748	2.208	2.296	2.245	m/s
$z_1 (\times 10^{-3})$	2.262	1.225	1.571	1.580	m
$z_1 - z_2 (\times 10^{-3})$	1.713	1.256	1.513	1.585	m
$z_2 - w (\times 10^{-3})$	3.734	2.968	2.957	2.861	m
<i>u</i>	0	25.8	27.3	25.6	N
<i>J</i>	7.633	4.025	3.755	3.696	-

mance index than the other three methods, but improves less the active control than Methods B and C. Fig.8 shows the spectral density computed from the time response of the acceleration of the car body obtained by four kinds of methods, and denotes that Method D decreases more the peak of spectral density in the frequency region 1 Hz~4 Hz than the other three methods. Fig.9 shows that the estimation result of the excitation from the road pro-

file obtained by the proposed disturbance observer is much improved as the exact and estimated time responses have good agreement, but the estimation result shown in this figure is less improved compared with that shown in Fig.7. Therefore, it is concluded from the experimental results that the proposed method (Method D) is better than Methods A, B and C in the vibration suppression of the car model and in robustness of the active control.

Table 3 RMS values of the time responses, and the performance index (2.5 Hz bandwidth)

	Method A	Method B	Method C	Method D	Unit
$\ddot{z}_1 (\times 10^{-1})$	5.166	3.270	3.219	3.150	m/s ²
$\dot{z}_1 (\times 10^{-2})$	3.143	1.800	1.803	1.859	m/s
$z_1 (\times 10^{-3})$	2.730	2.020	2.216	2.159	m
$z_1-z_2 (\times 10^{-3})$	1.372	1.351	1.443	1.378	m
$z_2-w (\times 10^{-3})$	2.505	1.469	1.593	1.463	m
u	0	19.8	24.9	25.2	N
J	2.674	1.071	1.038	0.994	-

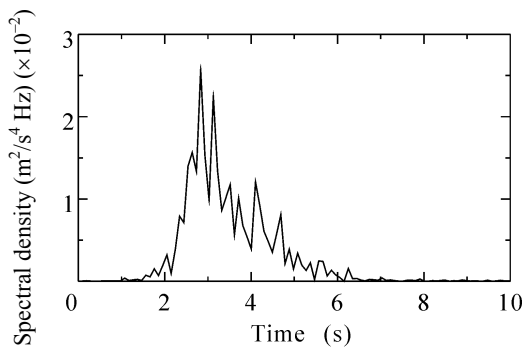

(a)

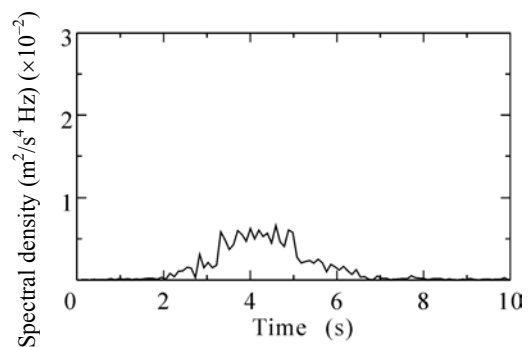

(b)

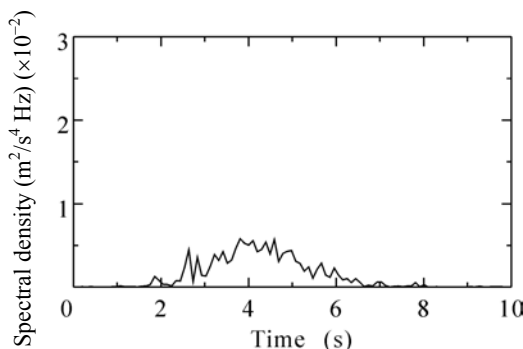

(c)

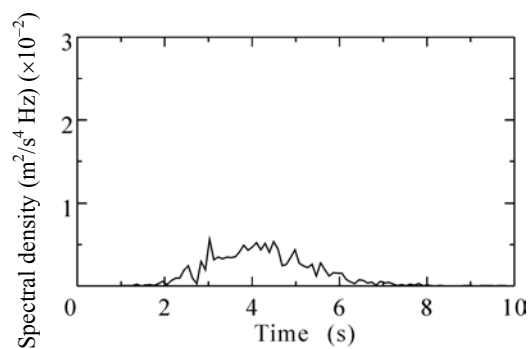

(d)

Fig.6 Spectral density of the acceleration of the car body (5 Hz bandwidth)

(a) Method A; (b) Method B; (c) Method C; (d) Method D

CONCLUSION

In this paper, a pneumatic active suspension system for a one-wheel car model was constructed by using fuzzy reasoning and a disturbance observer. The active control force was obtained by actuating a pneumatic actuator, and the performance degradation in the vibration suppression of the

car model due to the delay of the pneumatic actuator was countered by inserting a phase lead-lag element as a compensator following the sensors to measure the acceleration, velocity and displacement of the car body. The active control consisted of a combination fuzzy and disturbance controls. The number of fuzzy control rules was decreased and the function-type fuzzy reasoning was proposed where the single input expressing the weighted sum of the acceleration, velocity and displacement of the car body was denoted in the precondition part, and the fuzzy control was implemented as the function of s in the conclusion part. The excitation from a road profile was effectively estimated by using the proposed disturbance observer, and the disturbance control was constructed from the estimate. The experimental results indicated that the proposed active suspension system with disturbance observer gave much improved performance in the vibration suppression of the car model and in robustness of the active control.

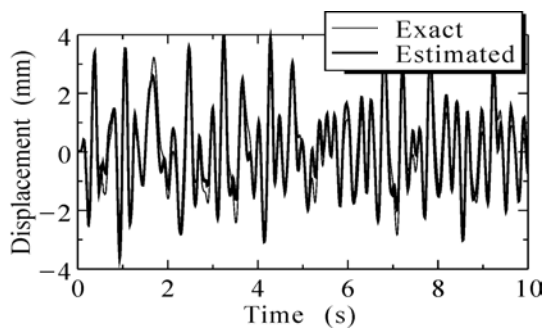
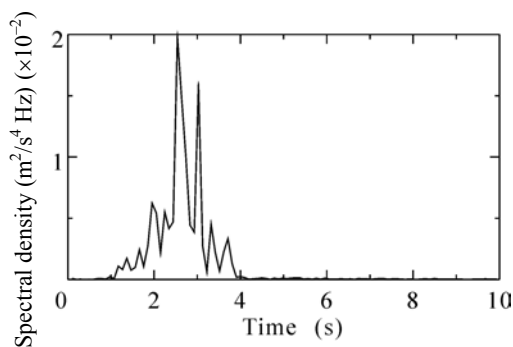
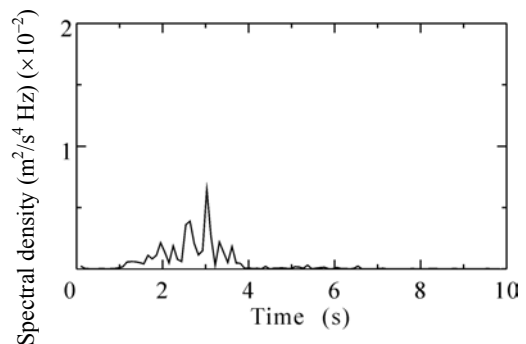

Fig.7 Estimation of the excitation from the road profile (5 Hz bandwidth)



(a)



(b)

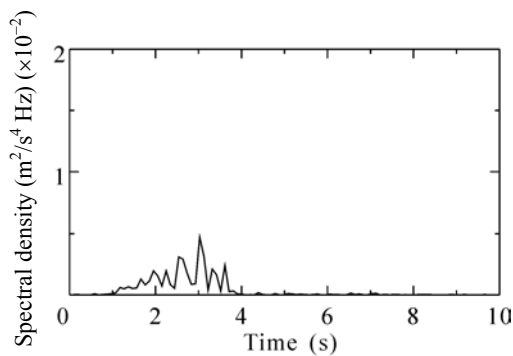

(c)

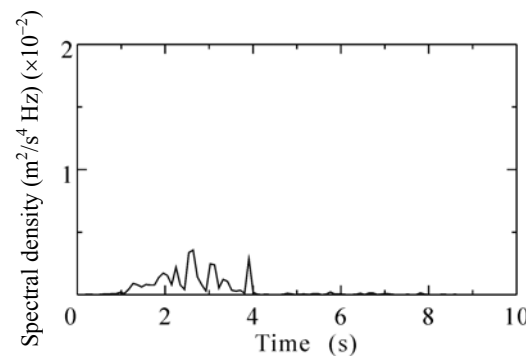

(d)

Fig.8 Spectral density of the acceleration of the car body (2.5Hz bandwidth)

(a) Method A; (b) Method B; (c) Method C; (d) Method D

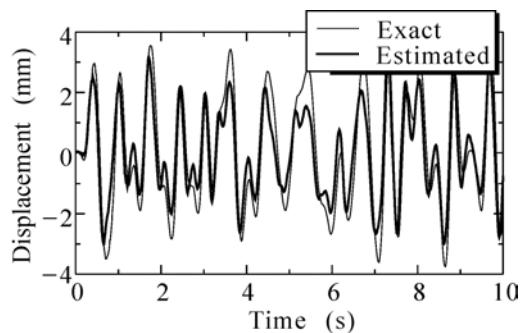

Fig.9 Estimation of the excitation from the road profile (2.5 Hz bandwidth)

References

- Fortman, T.E., Hitz, K.L., 1977. An Introduction to Linear Control Systems. Marcel Dekker, New York.
- Hác, A., 1986. Stochastic optimal control of vehicle with elastic body and active suspension. *ASME Journal Dynamic Systems, Measurement, and Control*, **108**: 106-110.
- Hrovat, D., 1993. Applications of optimal control of advanced automotive suspension design. *ASME Journal Dynamic Systems, Measurement, and Control*, **115**: 328-342.
- Kurimoto, M., Yoshimura, T., 1998. Active suspension of passenger cars using sliding mode controller (Based on reduced models). *International Journal of Vehicle Design*, **19**(4):402-414.
- Lin, Y.J., Lu, Y.Q., Padovan, J., 1993. Fuzzy logic control of vehicle suspension systems. *International Journal of Vehicle Design*, **14**(5/6):457-470.
- Moran, A., Nagai, M., 1994. Optimal active control of nonlinear vehicle suspensions using neural networks. *JSME International Journal*, **37**(4):707-718.
- Roukieh, S., Titli, A., 1993. Design of Active and Semi-Active Automotive Suspension Using Fuzzy Logic. IFAC 12th World Congress Preprints of Papers, Sydney, **2**:253-257.
- Yeh, E.C., Tsao, Y.J., 1994. A fuzzy preview control scheme of active suspension for rough road. *International Journal of Vehicle Design*, **15**(1/2):166-180.
- Yoshimura, T., Sugimoto, M., 1990. Active suspension for a vehicle travelling on flexible beams with an irregular surface. *Journal of Sound and Vibration*, **138**(3):433-445.
- Yoshimura, T., Isari, Y., Li, Q., Hino, J., 1997a. Active suspension of motor coaches using skyhook damper and fuzzy logic controls. *Control Engineering Practice*, **5**(2):175-184.
- Yoshimura, T., Nakaminami, K., Hino, J., 1997b. A semi-active suspension with dynamic absorbers of ground vehicles using fuzzy reasoning. *International Journal of Vehicle Design*, **18**(1):19-34.
- Yoshimura, T., Kume, A., Kurimoto, M., Hino, J., 2001. Construction of an active suspension system of a quarter car model using the concept of sliding mode control. *Journal of Sound and Vibration*, **239**(2): 187-199.
- Yoshimura, T., Hiwa, T., Kurimoto, M., Hino, J., 2003. Active suspension of a one-wheel car model using fuzzy reasoning and compensators. *International Journal of Vehicle Autonomous Systems*, **1**(2): 196-205.
- Yoshimura, T., Watanabe, K., 2003. Active suspension of a full car model using fuzzy reasoning based on single input rule modules with dynamic absorbers. *International Journal of Vehicle Design*, **31**(1):22-40.

Welcome visiting our journal website: <http://www.zju.edu.cn/jzus>

Welcome contributions & subscription from all over the world

The editor would welcome your view or comments on any item in the journal, or related matters

Please write to: Helen Zhang, Managing Editor of JZUS

E-mail: jzus@zju.edu.cn Tel/Fax: 86-571-87952276