



Prediction and analysis model of temperature and its application to a natural ventilation multi-span plastic greenhouse equipped with insect-proof screen *

LIU Shu-zhen (刘淑珍)^{†1,2}, HE Yong (何勇)^{†1}, ZHANG Yu-bao (张玉宝)³, MIAO Xiang-wen (苗香雯)¹

⁽¹⁾School of Biosystems Engineering and Food Science, Zhejiang University, Hangzhou 310029, China)

⁽²⁾Department of Mechanical Engineering, Ningbo University of Technology, Ningbo 315016, China)

⁽³⁾Information Engineering Department, Zhejiang Textile and Fashion Vocational Technology College, Ningbo 315211, China)

[†]E-mail: shuzhenl@163.com; yhe@zju.edu.cn

Received Dec. 31, 2004; revision accepted Mar. 13, 2005

Abstract: The natural ventilation widely used in greenhouses has advantages of saving energy and reducing expense. In order to provide information for climate control of greenhouse, a model was developed to predict the variation of air temperature in the naturally ventilated greenhouse equipped with insect-proof screen. Roof ventilation and combined roof and sidewall ventilation were considered in the model. This model was validated against the results of experiments conducted in the greenhouse when the wind was parallel to the gutters. The model parameters were determined by the least squares method. In the used model, effects of wind speed and window opening height on the air temperature variation were analyzed. Comparison between two types of ventilation showed that there existed a necessary ventilation rate which results in air temperature decrease in natural ventilation under special climatic conditions. In our experiments when wind speed was less than 3.2 ms⁻¹, wind had a more gradual effect on greenhouse temperature for roof ventilation, compared with combined roof and sidewall ventilation, which had greater air temperature decrease than roof ventilation only.

Key words: Greenhouse, Natural ventilation, Temperature, Model

doi:10.1631/jzus.2005.B0523

Document code: A

CLC number: S625.3

INTRODUCTION

The use of plastic greenhouses is rapidly expanding in China with multi-span greenhouses being the most common type. For all these greenhouses, ventilation performance is a major factor in production, influencing both climatic control and yield quality over much of the year. Natural ventilation uses very little external energy as compared with forced ventilation, but it increases the complexity of

greenhouse structures and makes climate control more difficult.

Natural ventilation is initiated by the pressure difference due to the outside wind or the greenhouse temperature gradient. Various techniques have been applied to measure greenhouse ventilation performance, such as tracer gas techniques, energy balances, and direct measurement of ventilation rate.

Previous studies on tracer gas techniques include those of Papadakis *et al.* (1996). Since then, tracer gas measuring techniques have been widely used (Whittle and Lawrence, 1960; Fernández and Bailey, 1992; Boulard and Draoui, 1995; Kittas *et al.*, 1995).

* Project (No. 50175101) supported by the National Natural Science Foundation of China

To explain the mechanisms involved in natural ventilation, direct measurements in the openings were performed by Boulard *et al.*(1996). The effect of ventilation configuration of a tunnel greenhouse with crop on airflow and temperature patterns was numerically investigated with the use of commercial computational fluid dynamics code by Bartzanas *et al.*(2004).

The energy balance method had been used to predict ventilation rates, temperature and humidity of greenhouse. Kittas *et al.*(1997) derived a model for predicting the ventilation flux of a greenhouse with ridge and side openings. This model was based on the temperature difference between the inside and outside of the greenhouse and the wind velocity. Subsequently, Teitel and Tanny (1999) developed a theoretical model for investigating the response of the greenhouse air temperature and humidity, to opening roof windows. This model was validated by experiments and the effects of wind speed, height of window opening and solar radiation on the ventilation process were studied.

Most of these studies mentioned above were conducted either by measuring ventilation flux, or by predicting air exchange rate and the variations in temperature and humidity under given climatic conditions. Few dealt with necessary ventilation rate that results in temperature decrease in natural ventilation. Few also compared the effects of wind and window opening height on greenhouse air temperature for roof ventilation with those for combined roof and sidewall ventilation. The objectives of this study were: (1) to develop a model to predict the variation of air temperature within greenhouse equipped with insect-proof screen; (2) to validate the model with experiments conducted in East-China type multi-span plastic greenhouse; (3) to study the effect of window opening area on the temperature variation; (4) to compare the effects of wind speed and window opening height on the reduction of air temperature for roof ventilation with those for combined roof and sidewall ventilation.

MODEL OF TEMPERATURE

In greenhouse ventilation two main driving forces are considered, a wind action which results in a

pressure field around the vents and a buoyancy effect (often called the stack effect) due to the vertical distribution of pressure which is linked to the gradient of air density between inside and outside. In this model both the stack effect and the direct effect of wind forces are considered. We consider a greenhouse without heating system, and the greenhouse air is warmer and more humid than those of the environment before vents are opened. Based on the first law of thermodynamics, the equation of the conservation of the greenhouse energy can be described as:

$$m_g c_p \frac{dT_i}{dt'} = mc_p (T_e - T_i) + qA \quad (1)$$

where: m_g is the mass of the greenhouse air in kg; c_p is the specific heat of air in kJ/(kg·°C); T_i is air temperature in greenhouse in °C; T_e is the ambient air temperature in °C; m is the mass of flow rate due to ventilation with anti-insect screen in kg/s; q is the sensible heat flux to the greenhouse air per unit floor area in W/m²; t' is the time in s; A is the greenhouse floor area in m².

Based on the "mixing ventilation" model as described by Linden *et al.*(1990), the temperature of the air leaving the vents is equal to the greenhouse air temperature. In contrast with T_i , T_e changes so slowly that it can be taken as a constant (Teitel and Tanny, 1999). To make the curve of ΔT as a function of time easy to read, the unit of time was substituted for minute. We denote the difference between the temperature of the air inside and outside the greenhouse as $\Delta T = T_i - T_e$, then Eq.(1) becomes:

$$m_g c_p \frac{d\Delta T}{dt} = -60mc_p \Delta T + 60qA \quad (2)$$

where: t is the time in minute.

When roof vents are opened only in multi-span plastic greenhouse, the mass flow rate through the openings can be estimated by the following relation (Kittas *et al.*, 1995):

$$m_v = \frac{\rho A_r}{2} C_d \left(2g \frac{\Delta TH_r}{4T_e} + C_r v^2 \right) \quad (3)$$

where: m_v is the mass flow rate due to ventilation

without anti-insect screen in kg/s; A_r is the total area of roof ventilation openings in m^2 ; C_d is the discharge coefficient of the window; g is the gravitational acceleration in m/s^2 ; H_r is the vertical height of the roof opening in m; C_r is the wind effect coefficient when roof vents were opened alone and v is the wind speed outside the greenhouse in m/s; ρ is the greenhouse air density in kg/m^3 .

When both roof and side vents are opened, the ventilation airflow as expressed by Kittas *et al.* (1997) was:

$$m_v = \rho C_d \left[\left(\frac{A_r A_s}{\sqrt{A_r^2 + A_s^2}} \right)^2 \left(2g \frac{\Delta T}{T_e} H_{rs} \right) + \left(\frac{A_r + A_s}{2} \right)^2 C_{rs} v^2 \right]^{0.5} \quad (4)$$

where: A_s is the total area of side ventilation openings in m^2 ; H_{rs} is the vertical distance between the mid-points of the side and roof window openings in m. C_{rs} is the wind effect coefficient when roof and side vents are opened.

For a greenhouse fitted with insect-proof screen, the ventilation flow rate can be calculated by the following simple equation (Pérez Parra *et al.*, 2004):

$$m = \varepsilon(2 - \varepsilon)m_v \quad (5)$$

where ε is the porosity of the screen.

Substitution Eq.(3) or Eq.(4) into Eq.(5) yields the ventilation flow rate for the two types of ventilation. Then after substituting Eq.(5) into Eq.(2), Eq.(2) can be solved.

EXPERIMENTAL GREENHOUSE AND MEASUREMENTS

Greenhouse

The experiments were carried out in a 504 m^2 polyethylene three-span greenhouse situated at the Institute of Agricultural Bio-Environment Engineering of Zhejiang University, China. The greenhouse was fitted with insect-proof screen with porosity of 35% and wire diameter of 0.22 mm. Its gutters oriented N-S. The greenhouse was equipped with one continuous roof vent located near the ridge on the east side of each span and four side vents, as shown in Fig.1. Each roof ventilator was 24 m long and 1 m

high; and the side vents were 62 m long and 1.3 m high. The environment was complex and there were some higher buildings (about 10 m high) in the east and some lower buildings (about 5 m high) in the other directions 500 m away from the greenhouse.

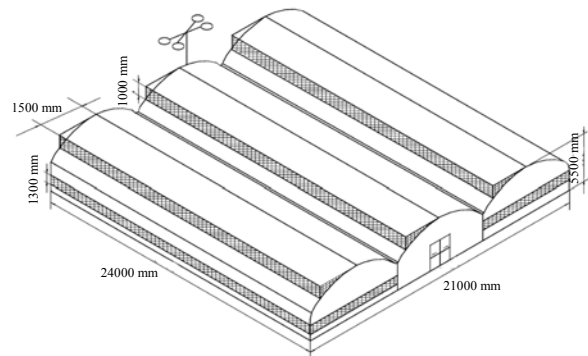

Fig.1 A schematic view of the experimental greenhouse

Measurements

The temperature measurements were made using intelligent temperature data recorders (ZDR-20) made by the Zhejiang University Electronic Equipment Factory. The temperature was measured at heights of 1.0 m, 2.0 m, 3.0 m and 4.0 m in the center of the greenhouse. No crop was grown in the greenhouse during the experiments. Environmental parameters were measured by a meteorological station over the top of the greenhouse at a height of 1.5 m.

The experiments were conducted over ten days between 11:00 a.m. and 12:00 a.m. From 10:00 to 11:00 a.m., all vents were closed completely. At 11:00 the continuous roof vents were opened over the first five days. In the second five days, both roof and side vents were opened at the same time of the day. All data was recorded every minute. The experimental data are shown in Table 1 and Table 2. T_{i0} is the initial air temperature in the greenhouse before the vents were opened. The wind was parallel to the gutters in our experiments.

RESULTS AND DISCUSSION

Determination of model parameters

Four parameters (C_d , C_r , C_{rs} , q) are required to solve Eq.(2). First, the sensible heat flux into the greenhouse air, q , is the sensible part of greenhouse solar absorption minus the sensible heat which is

Table 1 Experimental conditions and model parameters when only roof vents were opened

Number of experiment	Date	T_{i0} (°C)	v (m/s)	R (W/m ²)	λ	C_r	C_d	T_e (°C)
1	Sept. 19	31.0	2.6	556	0.024	0.0483	0.115	25.9
2	Sept. 20	40.3	2.1	342	0.028	0.0531	0.104	28.2
3	Sept. 21	22.3	3.2	59	0.021	0.0230	0.132	20.0
4	Sept. 22	39.9	2.4	417	0.017	0.0496	0.142	22.5
5	Nov. 6	20.4	2.6	112	0.03	0.0464	0.156	16.6

Table 2 Experimental conditions and model parameters when both roof vents and side vents were opened

Number of experiment	Date	T_{i0} (°C)	v (m/s)	R (W/m ²)	λ	C_{rs}	C_d	T_e (°C)
6	Nov. 3	32.5	1.8	579	0.019	0.0410	0.102	25.8
7	Nov. 4	32.8	2.3	592	0.027	0.0298	0.124	24.5
8	Nov. 5	30.3	2.6	210	0.03	0.0358	0.182	21.9
9	Nov. 7	36.4	1.6	492	0.032	0.0432	0.107	20.3
10	Nov. 8	37.5	1.7	503	0.025	0.0439	0.112	20.6

transferred through the cover and stored in the thermal mass such as soil. When $m=0$, that means the greenhouse is closed completely, q can be calculated using Eq.(1). In each experiment, the rate of air temperature increase can be obtained by the data sampled in the closed greenhouse between 10:00 and 11:00. For a given greenhouse, q changes with the solar radiation, R , which can be expressed by $q=\lambda R$. Experimental data showed that it takes approximately 25–35 min for temperature to reach a stable value. In each experiment R can be taken approximately as a constant because its increasing rate is not more than 5% during the period. Then the average value of λ became an input of the model.

Eq.(2) was solved numerically with MATLAB software. C_d , C_r or C_{rs} were estimated as shown in Table 1, Table 2, by minimizing the sum of squares of the deviations between the predicted and measured ΔT . The average value of C_d was 0.127 which is lower than that obtained by Kittas *et al.*(1997); and Andre and Albright (1994). The average value of C_r (0.044) was higher than C_{rs} (0.038), which is consistent with the conclusion obtained by Kittas *et al.*(1997). The values of C_d , C_r and C_{rs} are of the same order in magnitude to those given by Pearson and Owen (1994), Boulard *et al.*(1996), Kittas *et al.*(1997), Pérez Parra *et al.*(2004), but not equal to them. These differences could be due to different greenhouse shape, window opening, the angle between the wind direction and the window, and the wind speed during the experiments.

Validation of the model

We fitted the above models to experimental data collected by roof ventilation and combined roof and sidewall ventilation respectively. Comparison between model predictions and experimental data is shown in Figs.2–3.

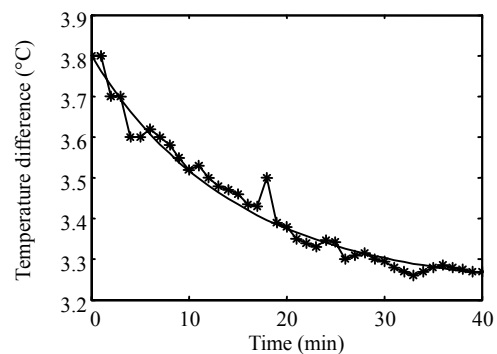
**Fig.2** Temperature difference with roof vents opened alone (ΔT) as a function of time (minute) (t)

*: Experiment results; —: Theoretical model of Experiment 5

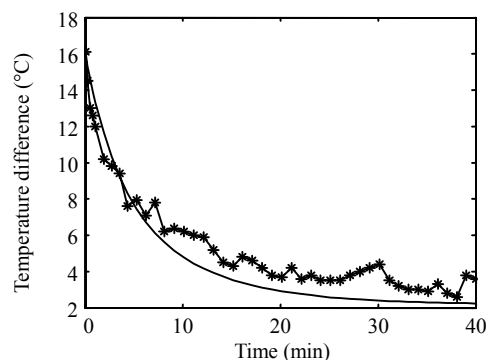
**Fig.3** Temperature difference with both roof vents and side vents opened (ΔT) as a function of time (minute) (t)

*: Experiment results; —: Theoretical model of Experiment 9

It was observed that after the roof vents were opened the air temperature within the greenhouse started to drop and approached steady state in about 35 min. For Experiment 5 (as shown in Fig.2), good agreement between the experimental data and the model was obtained for the parameter $C_d=0.156$, $C_r=0.0464$, with squared correlation, $r^2=0.97$. The values of C_d and C_r for the Experiments 1–5 are given in Table 1. The average value of r^2 for the five experiments was 0.96.

After both roof and side vents were opened, the air temperature within the greenhouse started to drop and approached steady state in about 25 min. For Experiment 9 (as shown in Fig.3), good agreement between the experimental data and the model was obtained for the parameter $C_d=0.107$, $C_{rs}=0.0432$, with squared correlation, $r^2=0.964$. The values of C_d and C_{rs} for Experiments 6–10 are given in Table 2. The average value of r^2 for the five experiments was 0.94.

Analysis and comparison

In this section, we use the model to analyze the effects of the wind speed and the height of window openings on the roof ventilation and combined roof and sidewall ventilation. Average values of C_d , C_r and C_{rs} , and the initial parameters (T_{i0} , T_e , R , v) of Experiment 7 were used in the calculation.

Effect of wind speed

The sensitivity of the model to wind speed is shown in Figs.4–5. Obviously, as compared to the combined roof and sidewall ventilation, wind has a more gradual effect on greenhouse temperature when the roof window is opened only. Papadakis *et al.*(1996) suggested that when wind velocity exceeded a certain value, the increasing of roof ventilation rate by increasing of wind speed exceeded that of roof and sidewall ventilation, and that the value of wind speed depends on the greenhouse type (height, span width, roof slope) and the ventilator geometry (height and length), the ventilator position on the roof and also on ΔT itself. In our experiments, when wind speed increases, the temperature decreases more greatly for roof ventilator than for roof and side ventilator.

Effect of vents height

The effects of the vents height on natural venti-

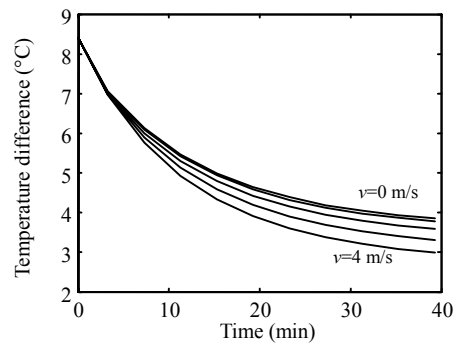

Fig.4 Temperature difference as a function of time with roof vents opened only, with different wind speed of 0, 1, 2, 3 and 4 m/s (from the top down)

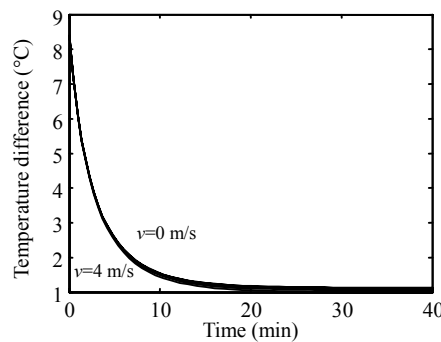

Fig.5 Temperature difference as a function of time with maximal side vents and maximal roof vents, with different wind speed of 0, 1, 2, 3 and 4 m/s (from the top down)

lation process are shown in Figs.6–9. As expected, a larger area of vents results in lower steady-state temperature difference.

Fig.6 shows the change in ΔT as a function of time, t , for various height of roof window opening in the range of 0.2–1 m. It was observed that the value of ΔT began to decrease after the roof opening height exceeded 0.4 m, and that the effect of the change in roof opening height on the values of ΔT at steady-state decreased with increasing height of the opening. According to Eq.(2), as long as the heat absorbed from sun radiation exceeds that discharged by ventilation, ΔT will increase. It indicates that, under special climate conditions, certain ventilation rate and certain roof opening height are required to decrease temperature.

Fig.7 and Fig.8 show the change of temperature ΔT as a function of time, t , for different roof opening height with maximal side vents unchanged and different side opening height with maximal roof vents unchanged respectively. Note that the effect of the change in vents opening height on the values of ΔT at

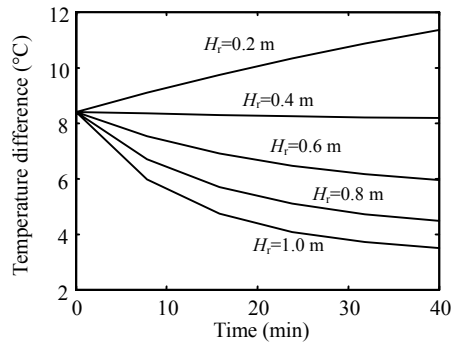

Fig.6 Temperature difference as a function of time for different roof opening heights of 0.2, 0.4, 0.6, 0.8 and 1.0 m (from the top down)

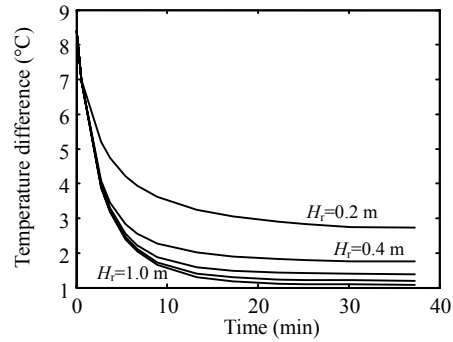

Fig.7 Temperature difference as a function of time for different roof opening heights of 0.2, 0.4, 0.6, 0.8 and 1.0 m (from the top down) with maximal side vents unchanged

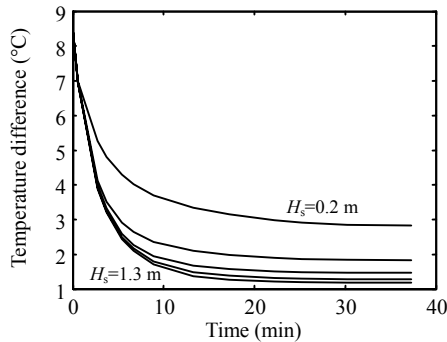

Fig.8 Temperature difference as a function of time for different side opening heights of 0.2, 0.4, 0.6, 0.8 and 1.3 m (from the top down) with maximal roof vents unchanged

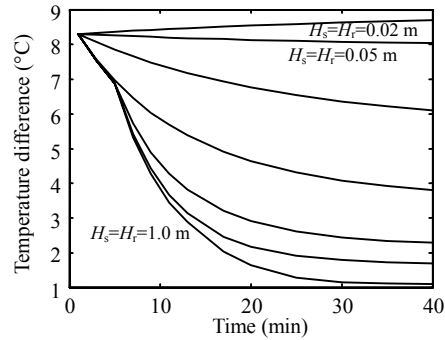

Fig.9 Temperature difference as a function of time for different roof and side opening heights of 0.02, 0.05, 0.2, 0.4, 0.6, 0.8 and 1.0 m (from the top down)

steady-state decreases with increasing height of opening, and that the vents opening height have similar effect on the ventilation process, which is due to the total length of the roof and side window is near.

Comparison of Fig.6 with Figs.7–9, shows that when roof window opening height increases, temperature difference decreases more rapidly in roof ventilation than in combined roof and sidewall ventilation. It indicates that roof ventilation is more sensitive to the height of roof opening.

Fig.9 shows the change of ΔT with time t , when roof and side opening height are changed simultaneously. We see the curves begin downward trend when both roof and side opening height exceed 0.05 m. For Eq.(2), as long as the heat absorbed from sun radiation exceeds that discharged by ventilation, ΔT will increase. In the same way, for combined roof and sidewall ventilation, there is a necessary ventilation rate and window opening height which results in temperature decrease under a special climate conditions.

The steady-state temperature difference

Fig.10 shows ΔT as a function of t , for maximal roof opening alone and combined maximal roof and side openings. The two curves are plotted using initial parameters and outside conditions of Experiment 9. It is observed that ventilation with combined maximal roof and side window opening area results in lower steady-state temperature difference than with maximal roof opening. In our experimental conditions, ventilation with combined maximal roof and side opening resulted in lower temperature difference compared with ventilation with maximal roof opening. In another study, Papadakis *et al.* (1996) observed that at low wind velocities the stack effect increases ventilation, while at high wind velocities roof ventilation alone is more efficient than the combination of roof and sidewall ventilation. Therefore under special environment conditions, we should use the model to predict whether the roof ventilation or combined roof and sidewall ventilation is efficient before temperature controlling.

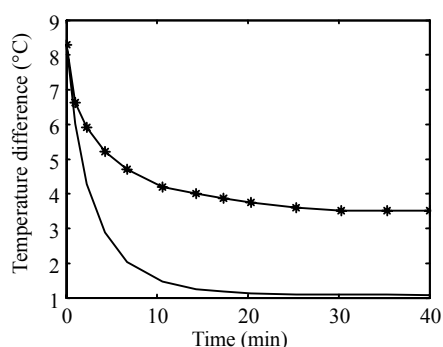

Fig.10 Temperature difference as a function of time
 *: For maximal roof opening alone; -: For combined maximal roof and side opening

CONCLUSION

A model was developed and validated for predicting the variation of air temperature within a natural ventilated greenhouse equipped with insect-proof screen. Analysis the effects of wind and vent opening height on the air temperature variation for roof ventilation and combined roof and sidewall ventilation led to the following conclusions.

For roof ventilation, the effect of wind speed on the air temperature variation inside a greenhouse is more obvious, but for combined roof and sidewall ventilation, it is not apparent. When roof windows are opened only or when both roof and side windows are opened, the steady-state of air temperature decreases with the increase in the opening height, but the increasing rate of the former is larger. At the same time, there is a necessary vents opening area which results in air temperature decrease in natural ventilation under special conditions. In our experiments, under the same climatic conditions, the temperature decrease is smaller for roof ventilation than for combined roof and sidewall ventilation.

For plants that are sensitive to air temperature, we can regulate window-opening area to meet requirements. According to real-time outside and inside climatic conditions, we can use the model to predict air temperature reduction achievable by natural ventilation. If the temperature decrease cannot meet the

requirement, active ventilation and other temperature reduction measures should be implemented.

References

- Andre, N., Albright, L.D., 1994. Criterion for establishing similar air flow patterns (isothermals) in slotted-inlet ventilated enclosures. *Trans. ASAE*, **37**:235-250.
- Bartzanas, T., Boulard, T., Kittas, C., 2004. Effect of vent arrangement on windward ventilation of a tunnel greenhouse. *Biosystems Engineering*, **88**(4):479-490.
- Boulard, T., Draoui, B., 1995. Natural ventilation of a greenhouse with continuous roof vents: Measurements and data analysis. *Journal of Agricultural Engineering Research*, **61**:27-36.
- Boulard, T., Meneses, J.F., Mermier, M., Papadakis, G., 1996. The mechanisms involved in the natural ventilation of greenhouse. *Agricultural and Forest Meteorology*, **79**: 61-77.
- Fernández, J.E., Bailey, B.J., 1992. Measurements and prediction of greenhouse ventilation rates. *Agricultural and Forest Meteorology*, **58**:229-245.
- Kittas, C., Draoui, B., Boulard, T., 1995. Quantification of the ventilation of a greenhouse with roof opening. *Agricultural and Forest Meteorology*, **77**:95-111.
- Kittas, C., Boulard, T., Papadakis, G., 1997. Natural ventilation of a greenhouse with ridge and side openings: Sensitivity to temperature and wind effects. *Trans. ASAE*, **40**(2):415-425.
- Linden, P.F., Lane-Serf, G.F., Smeed, D.A., 1990. Emptying filling Boxes: The fluid mechanics of natural ventilation. *Journal of Fluid Mechanics*, **212**:309-335.
- Papadakis, G., Mermier, M., Meneses, J.F., Boulard, T., 1996. Measurements and analysis of air exchange rates in a greenhouse with continuous roof and side openings. *Journal of Agricultural Engineering Research*, **63**:219-228.
- Pearson, C.C., Owen, J.E., 1994. The resistance to air flow of farm building ventilation components. *Journal of Agricultural Engineering Research*, **57**:53-65.
- Pérez Parra, J., Baeza, E., Montero, J.I., Bailey, B.J., 2004. Natural ventilation of parral greenhouse. *Biosystems Engineering*, **87**(3):355-366.
- Teitel, M., Tanny, J., 1999. Natural ventilation of greenhouse: Experiments and model. *Agricultural and Forest Meteorology*, **96**:59-70.
- Whittle, R.M., Lawrence, W.J.C., 1960. The climatology of glasshouses. II. ventilation. *Journal of Agricultural Engineering Research*, **5**:36-41.